



Aliso OII I.17-02-002: Workshop 3 Input Data Development and Capacity Studies

Khaled Abdelaziz, PhD, PE
Natural Gas Modeling Lead
Energy Division
California Public Utilities Commission

July 28, 2020



Presentation Outline

- Introduction
- Workshop 2 Recap
- Part I: Hourly Profiles of Natural Gas Use
 - Core Customers Profiles
 - Noncore Commercial & Industrial Customers Profiles
 - Electric Generation Profiles
 - Other Profiles
 - Conclusions
 - Q&A
- Part II: Capacity Studies Preliminary Results
 - Southern Zone Capacity
 - Northern Zone Capacity
 - Conclusions
 - Q&A



Introduction

- Previous hydraulic modeling updates covered the following:
 - Workshop 1 (June 2019):
 - Presented an analysis on gas scheduling and historical receipt point utilization and concluded an RPU range of 85%-95%.
 - Workshop 2 (November 2019):
 - Validated many peak design day parameters of SoCalGas as well as numerous short- and long-term natural gas demand forecasts.
 - Presented methodology on deriving core hourly gas profiles and preliminary results by ZIP code.



Introduction

- Workshop 3 (Today):
 - Presents final analysis and adoption of hourly natural gas use profiles.
 - Validates hourly gas use profiles used by SoCalGas.
 - Presents preliminary results on capacity studies:
 - Capacity studies were not proposed in the scenarios framework.
 - Capacity studies are designed to understand the hydraulics of SoCalGas network and reveal possible bottlenecks or unfavorable competition between different parts of the network.
 - Capacity studies pave the road towards Phase III of this OII.

Workshop 2 Recap





Hourly Core Gas Demand Profiles

Workshop 2

- Why derive hourly gas demand profiles?
 - Running transient simulations requires time-varying boundary conditions, i.e. the varying hourly gas demand must be introduced in order to determine its effect on gas flow and pressure (drop or spike). The flow is assumed to have a periodicity of one day, hence profiles need to be derived for only 24 hours.



Hourly Core Gas Demand Profiles

Workshop 2

- Methodology: For each Core customer subclass, ZIP code, each month
 - Filter out weekends.
 - Calculate the daily gas demand for all customers (within that ZIP code and subclass).
 - Assign the daily gas demand to 1 of 3 bins:
 - Average demand: 45th to 55th percentile (mid-point is 50% (average gas demand)).
 - Peak demand : 87.5th to 92.5th percentile (mid-point is 90% (1-in-10 gas demand)).
 - Extreme demand : 94.3th to 100th percentile (mid-point is 97% (1-in-35 gas demand)).
 - For each of the 3 bins:
 - Normalize the daily profile by the hourly mean (i.e. set the daily usage to 1 by dividing the hourly use by the mean hourly use (total daily use/24)).
 - For each hour, pick the median among all the days in that bin.
 - Renormalize the curves using their means.
 - The result is 3 normalized profiles for each ZIP code, month, each subclass.



Hourly Core Gas Demand Profiles

Workshop 2

- If only 2018 AMI data is used, this methodology results in approximately 3 days being used to derive the average hourly gas profile and 1-2 days to derive the peak and extreme peak hourly gas profiles. The days may vary by month, ZIP code, and customer class.
- If 2017 and 2018 AMI data is used, the number of days used to generate the profiles will double, but some difficulty will arise due to the varying number of customers who are AMI-enabled. CPUC decided to use only 2018 data.
- A **higher load factor** doesn't necessarily reflect a higher peak demand (CCF/hr) because the gas demand profiles are **normalized**. In other words, a ZIP code with a (mean-to-peak) load factor of 1.4 and daily demand of 100CCF, will have a higher peak than a ZIP code with a load factor of 1.7 and daily demand of 50CCF/day ($100/24 * 1.4 > 50/24 * 1.7$)



Sample Gas Demand Profile (Residential)

Workshop 2

ZIP code: 93427
Load type: Extreme

- Month
- 1
 - 2
 - 3
 - 4
 - 5
 - 6
 - 7
 - 8
 - 9
 - 10
 - 11
 - 12

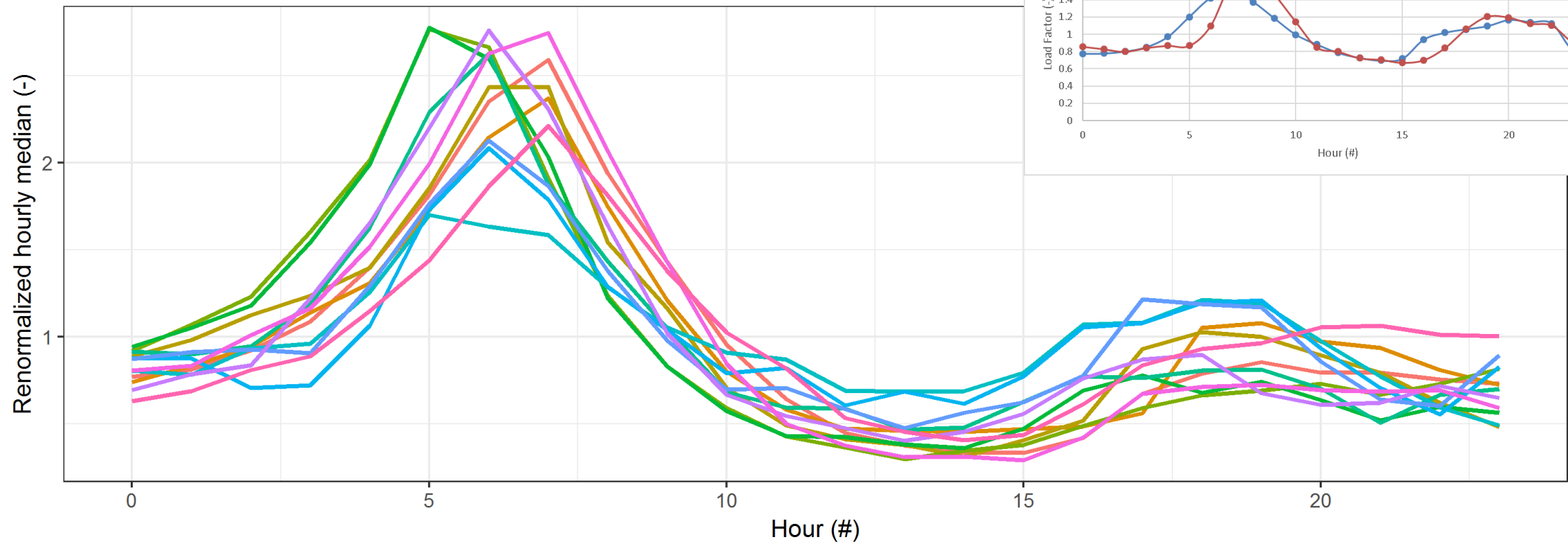

Source: Data Request #5: AMI_RES_10PERCENT_DATA_ZIPS50.csv



Sample Gas Demand Profile (Residential)

Workshop 2

ZIP code: 90001
Load type: Average

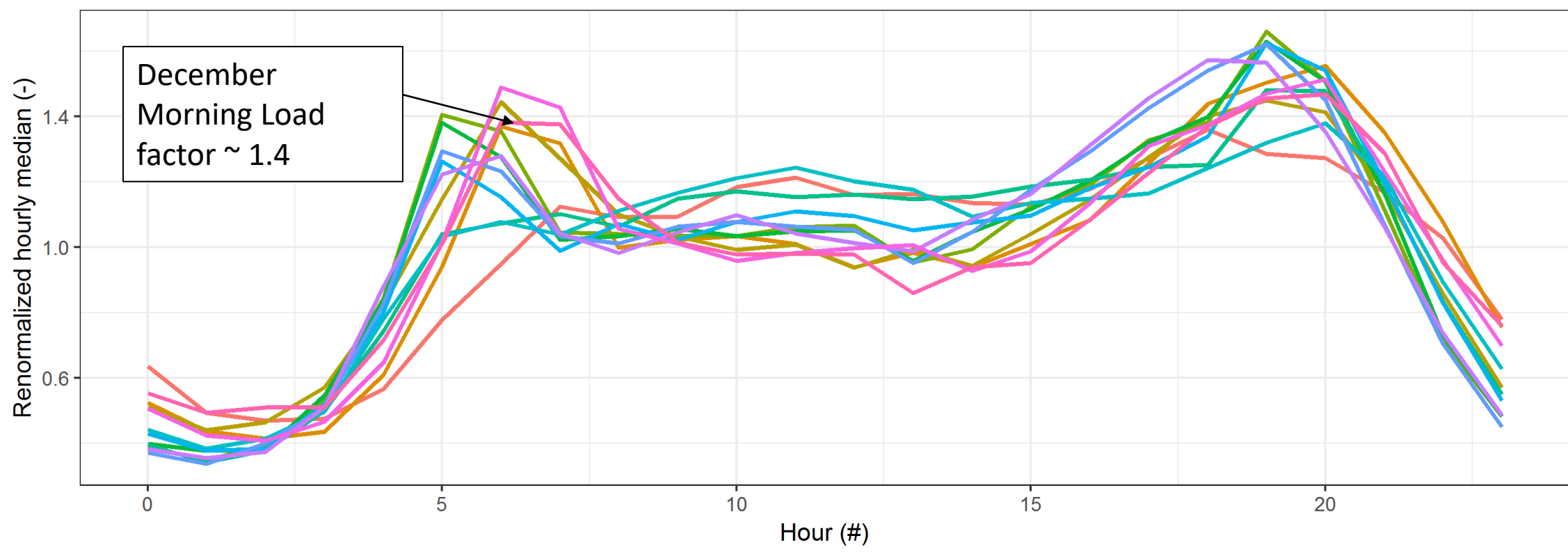

Source: Data Request #5: AMI_RES_10PERCENT_DATA_ZIPS01.csv



Sample Gas Demand Profile (Residential)

Workshop 2

ZIP code: 90001
Load type: Extreme

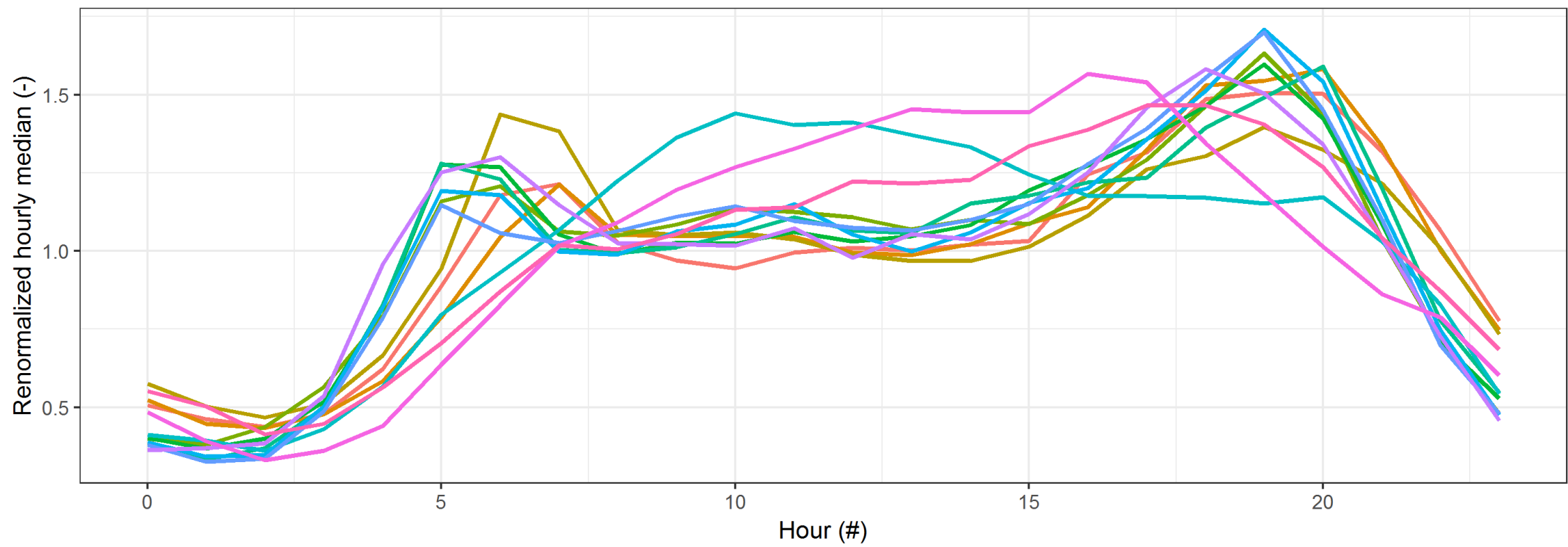

Source: Data Request #5: AMI_RES_10PERCENT_DATA_ZIPS01.csv



Conclusions: Hourly Core Profiles

Workshop 2

- Analysis of 2018 AMI data shows a lot a variability across the different ZIP codes and months which merits the inclusion of such geographical and seasonal granularity in the hydraulic modeling.
- Compared to SoCalGas Core hourly profile, some ZIP codes have a higher load factor, while other ZIP codes have a lower load factor.



Next Steps: Merging Hourly Profiles

Workshop 2

- Synergi has a limitation on the number of profiles that can be used in a single run (~2,000 profiles).
- Profiles of subclasses of Core customers must be merged together to reduce the number of total profiles.
- More merging may be possible by climate zones or by geographical proximity of ZIP codes. Merging profiles by ZIP code will also average out outliers.
- Sensitivity on the percent of customers that would yield a correct representative profile.

Part I: Hourly Profiles of Natural Gas Use

SoCalGas Core Customers Profiles





Core Customers Profiles

- Why aggregate hourly profiles?
 - A distribution network can service multiple ZIP codes, and aggregation or merging must be performed at least to match the number of distribution networks, which are represented by demand nodes in Synergi Gas.
 - There is a limitation in Synergi Gas on the number of time-dependent profiles that can be loaded (2,500 profiles in v 4.9.1). These profiles are not necessarily flow profiles but could also be pressure profiles, operational actions profiles, i.e. time-dependent profiles.
- Aggregation can be spatial (i.e. by ZIP codes) or temporal (i.e. across a few selected days or a few months), or both.
 - For space aggregation, the weight or the contribution of each ZIP code and subclass to core gas demand must be derived using the available Advanced Meter Infrastructure (AMI) data.
 - For time aggregation, the weight of each day or month must be specified or derived.



Core Customers Profiles

- Is 10% of AMI data sufficient to derive weights?
 - AMI was used to derive the average (45th to 55th percentile), peak (87.5th to 92.5th percentile), and extreme peak (94.3th to 100th percentile) gas use profiles of each ZIP code, subclass, and month.
 - Since Data Request #5 obtained 2018 AMI data for 10% of the customers,⁺ the derived core gas demand was scaled upwards using the number of customers by ZIP code, by subclass, and by month, which is available from Data Request #6.
 - To verify the scaling, a comparison between CPUC estimate of daily total core use from AMI data and SoCalGas estimate (DR #6, Q1) was made.

⁺Full AMI data was obtained for ZIP codes that contained 100 or fewer meters



Core Customers Profiles

Comparison between CPUC Estimate of Core Gas Demand in 2018 Using Scaled AMI Data (Data Request #5) and SoCalGas Provided Estimate in Data Request #6.

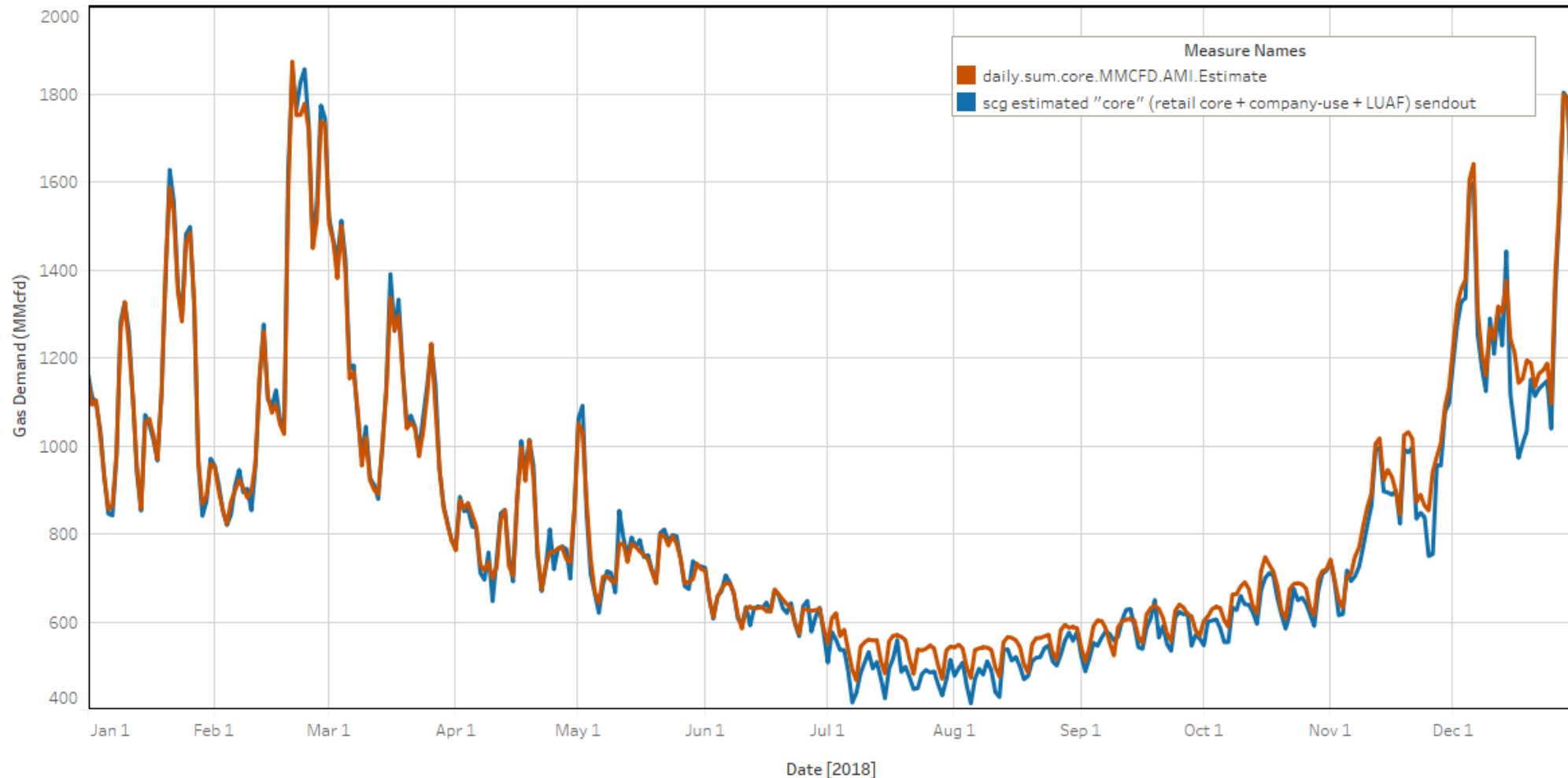



Core Customers Profiles

- Weights calculation:
 - Spatial aggregation:
 - For each day in 2018, use AMI data to calculate the contribution of each ZIP code and each subclass to the total core gas demand use.
 - Temporal aggregation:
 - For the summer season, calculate the mean of the contribution (of each ZIP code and each subclass) over months 7, 8, and 9.
 - For the winter season, calculate the mean of the contribution (of each ZIP code and each subclass) over months 11,12,1,and 2.+
 - Sum contributions of ZIP codes (~600 ZIP codes) to Synergi demand nodes (157 Core SoCalGas nodes)

+The remaining months (i.e. 3,4,5,6,10) will be assigned to "Other" category



Core Customers Profiles (Peak Load)

Normalized Hourly Weighted Average Gas Demand by Node by Season

factor(season) - Other - Summer - Winter

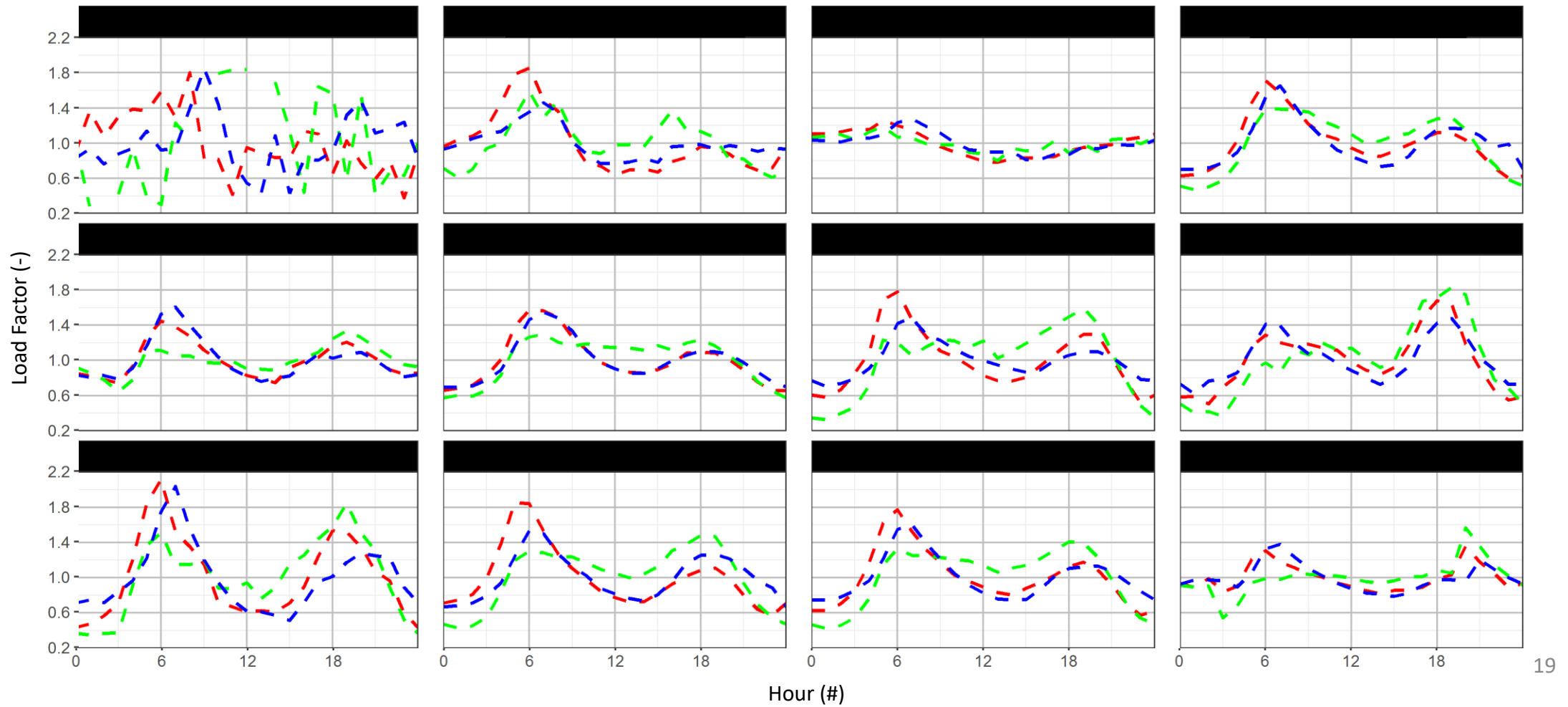



Core Customers Profiles

- For validation purposes, a second variation of aggregation was attempted:
 - Full spatial aggregation (all ZIP codes are aggregated).
 - Monthly temporal aggregation (weights are calculated by averaging all daily weights in a given month, for each month).
 - Plots are shown in the following 5 slides.
- For validation purposes, a third variation of aggregation was attempted:
 - Full spatial aggregation (all ZIP codes are aggregated).
 - Seasonal temporal aggregation (weights are calculated by averaging all daily weights in a given season, for each season).



Core Customers Profiles (Average Load)

- Month
- 1 (Red)
 - 2 (Orange)
 - 3 (Yellow)
 - 4 (Light Green)
 - 5 (Green)
 - 6 (Dark Green)
 - 7 (Cyan)
 - 8 (Blue)
 - 9 (Light Blue)
 - 10 (Purple)
 - 11 (Pink)
 - 12 (Magenta)

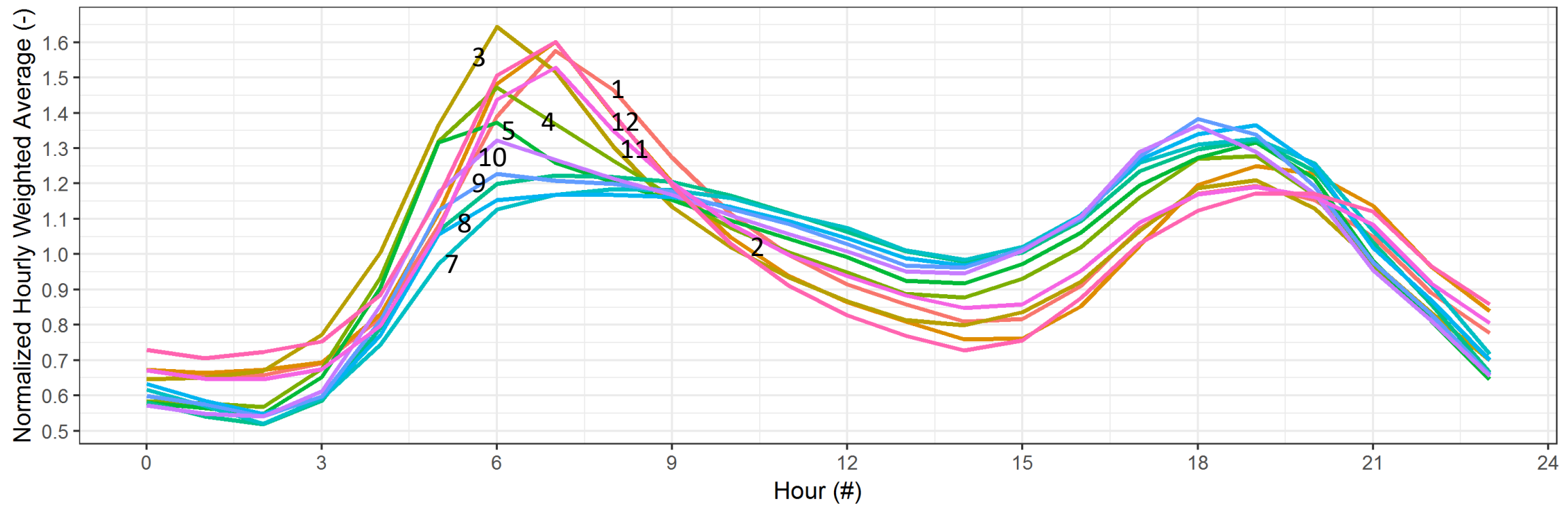

Source: Data Request #5: Response 1: Core Customers



Core Customers Profiles (Peak Load)

Month

1	4	7	10
2	5	8	11
3	6	9	12

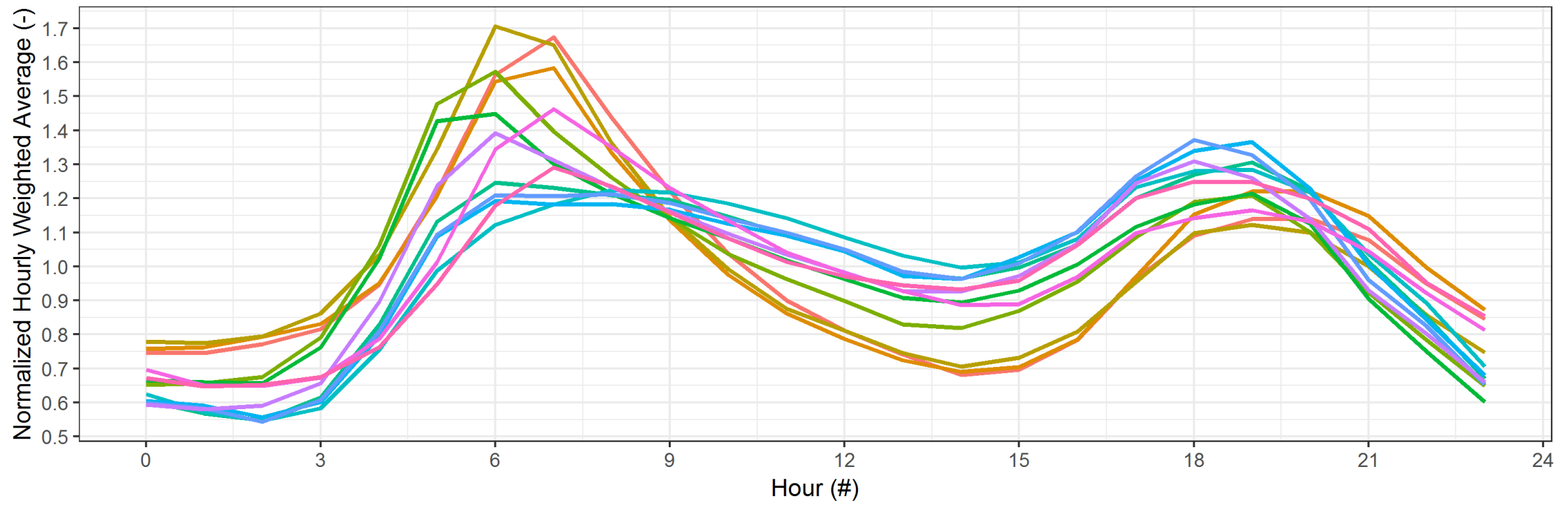

Source: Data Request #5: Response 1: Core Customers



Core Customers Profiles (Extreme Load)

Month
1 2 3 4 5 6 7 8 9 10 11 12

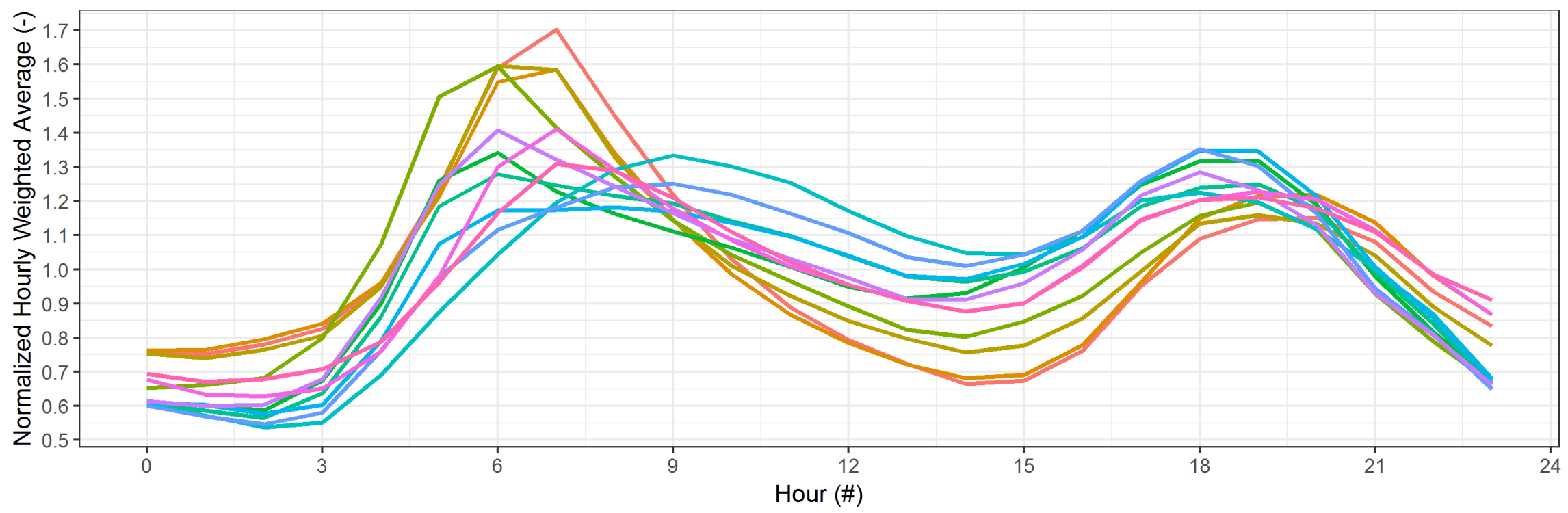

Source: Data Request #5: Response 1: Core Customers



Morning Load Factor (Core Customers)

factor(load) Average Extreme Peak

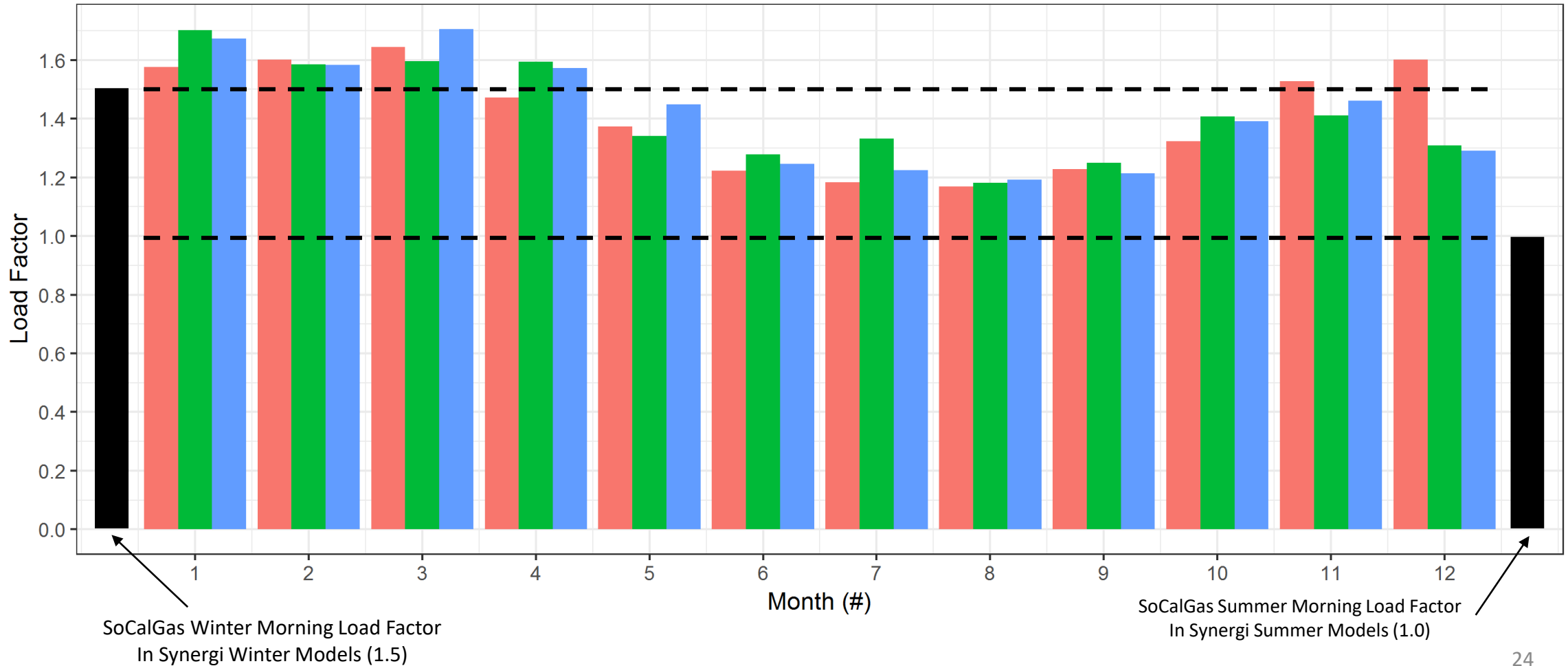



Evening Load Factor (Core Customers)

factor(load) Average Extreme Peak

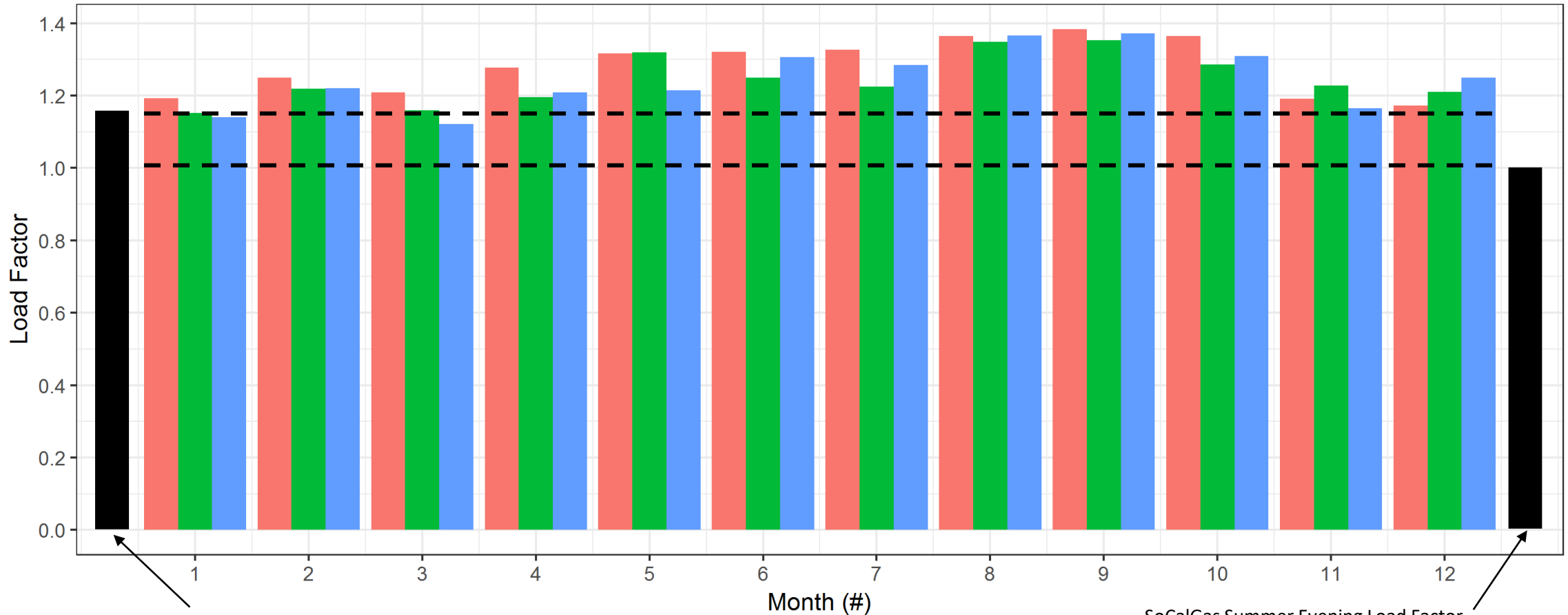

SoCalGas Winter Evening Load Factor
In Synergi Winter Models (1.16)

SoCalGas Summer Evening Load Factor
In Synergi Summer Models (1.0)



Core Customers Profiles (Full Aggregation)

Normalized Hourly Weighted Average Gas Demand by Season
Core Customers using Peak Shapes

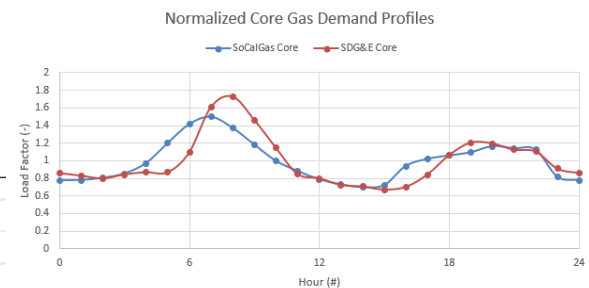
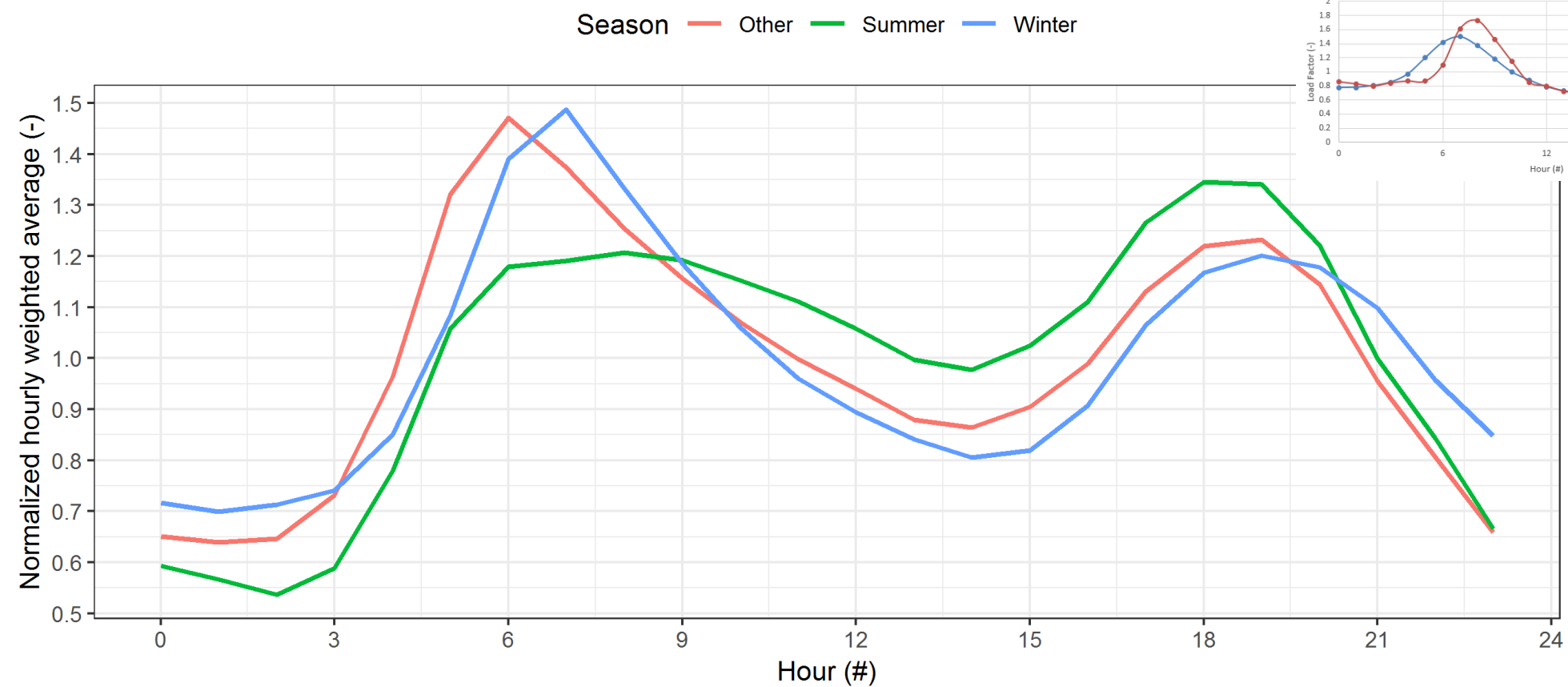

Source: DR#5: Response 1: Core Customers. Shapes previously derived by ZIP code and customer subclass (Residential, Commercial, Industrial, and NGV) were averaged using weights, which were derived by averaging daily 2018 gas demand for the corresponding season, which are months 1,2,11,12 for "Winter", 7,8,9 for "Summer", and 3,4,5,6,10 for "Other".

Part I: Hourly Profiles of Natural Gas Use

SoCalGas & SDG&E Noncore Commercial & Industrial Customers





Noncore Commercial & Industrial Customers

- Response to Data Request #3, Follow up #5:
 - The SoCalGas and SDG&E Noncore and SMEG (small EG) demand profiles are used to simply reflect that the small customers represented by these profiles do not operate on a 24-hour basis; half of the daily demand from the evening hours was therefore shifted to business hours.
- Staff is adopting this profile for Noncore customers which has a load factor of 1.5, which is comparable to Core customers.

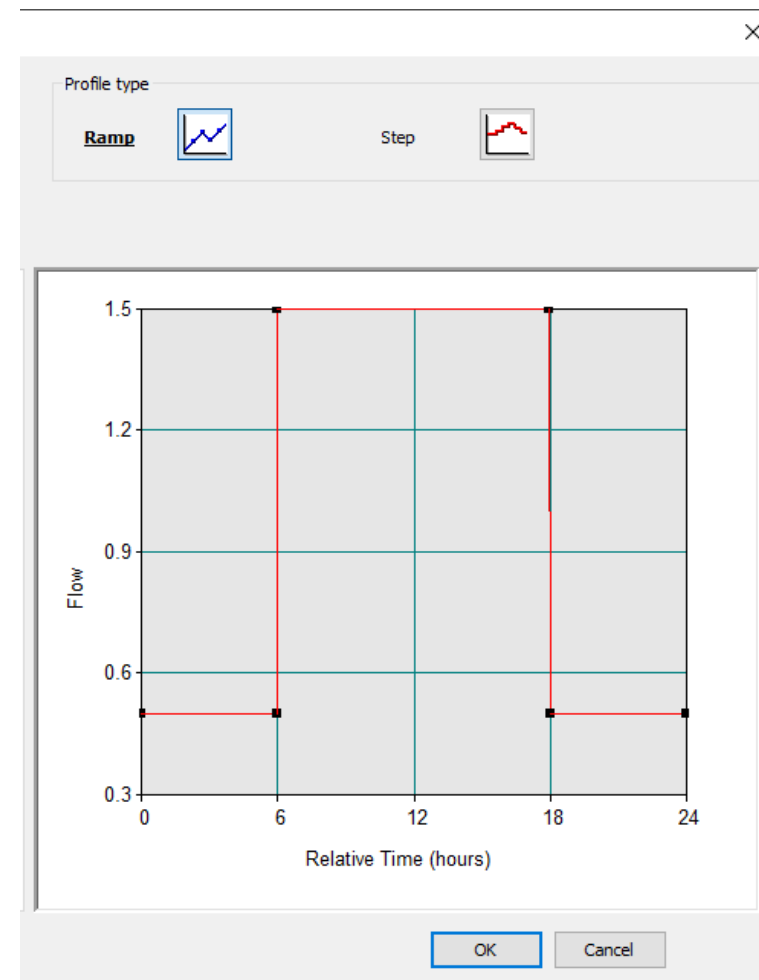

Part I: Hourly Profiles of Natural Gas Use

SoCalGas Electric Generation Customers





Electric Generation Customers (1-in-10)

- Electric generation fuel burn profiles were obtained from Energy Division's own Production Cost Modeling by unit by day for each study year.
- Among 100 cases or permutations of weather years and load forecast errors (20 weather years X 5 load forecast errors), 2 cases were selected that represented the 90th percentile of monthly gas use. This corresponded to a zero forecast error, weather year 2013 for the summer, and weather year 2014 for the winter.
- Subsequently the day with the highest EG demand in December was selected to represent the winter EG demand, while the day with the highest demand in the summer season was selected to represent the summer EG demand. The latter occurred in September.
- Fully aggregated hourly profiles are shown in the next 2 slides.



Aggregate EG Profiles for Summer

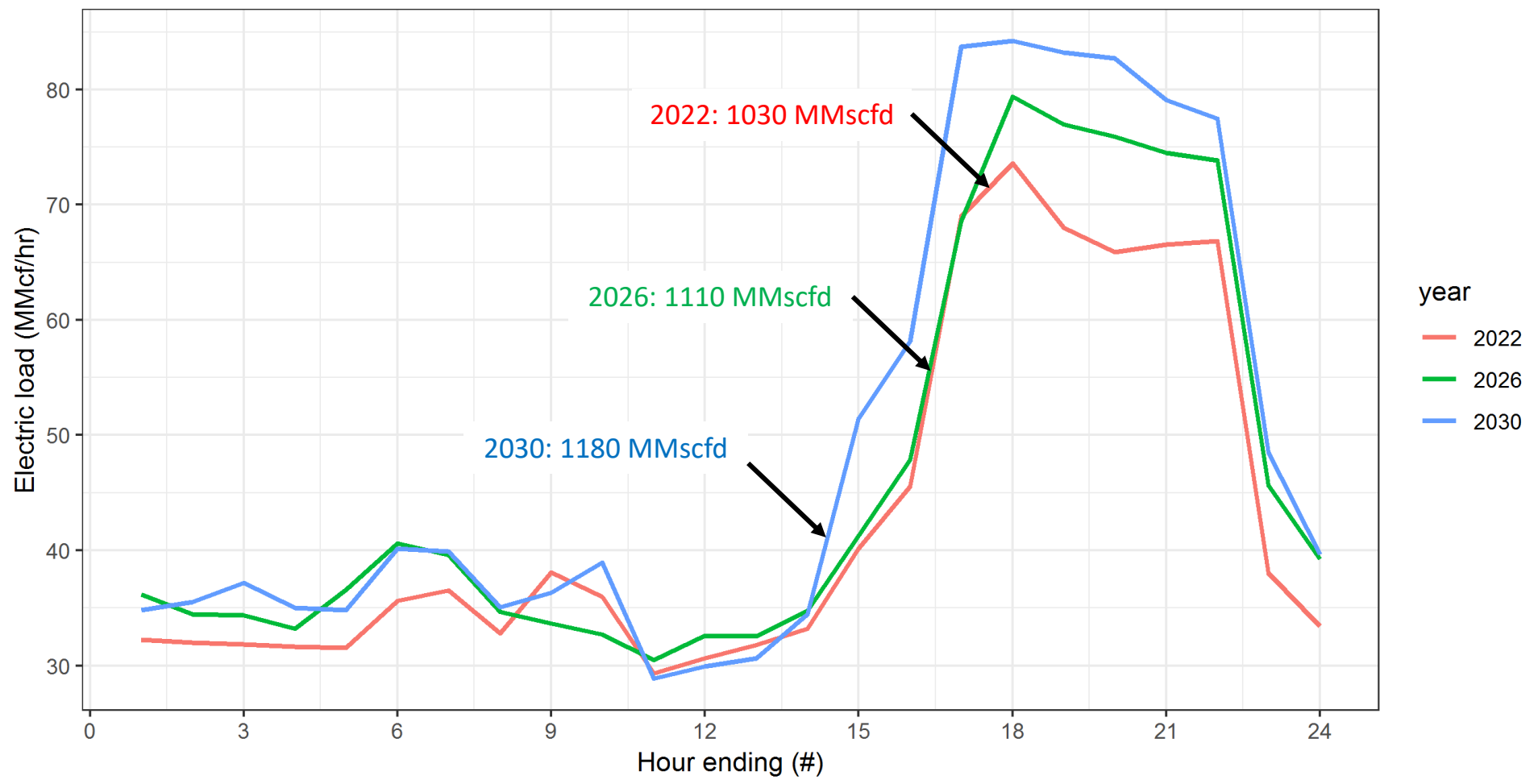

Source: Production Cost Modeling, Energy Division



Aggregate EG Profiles for Winter (1-in-10)

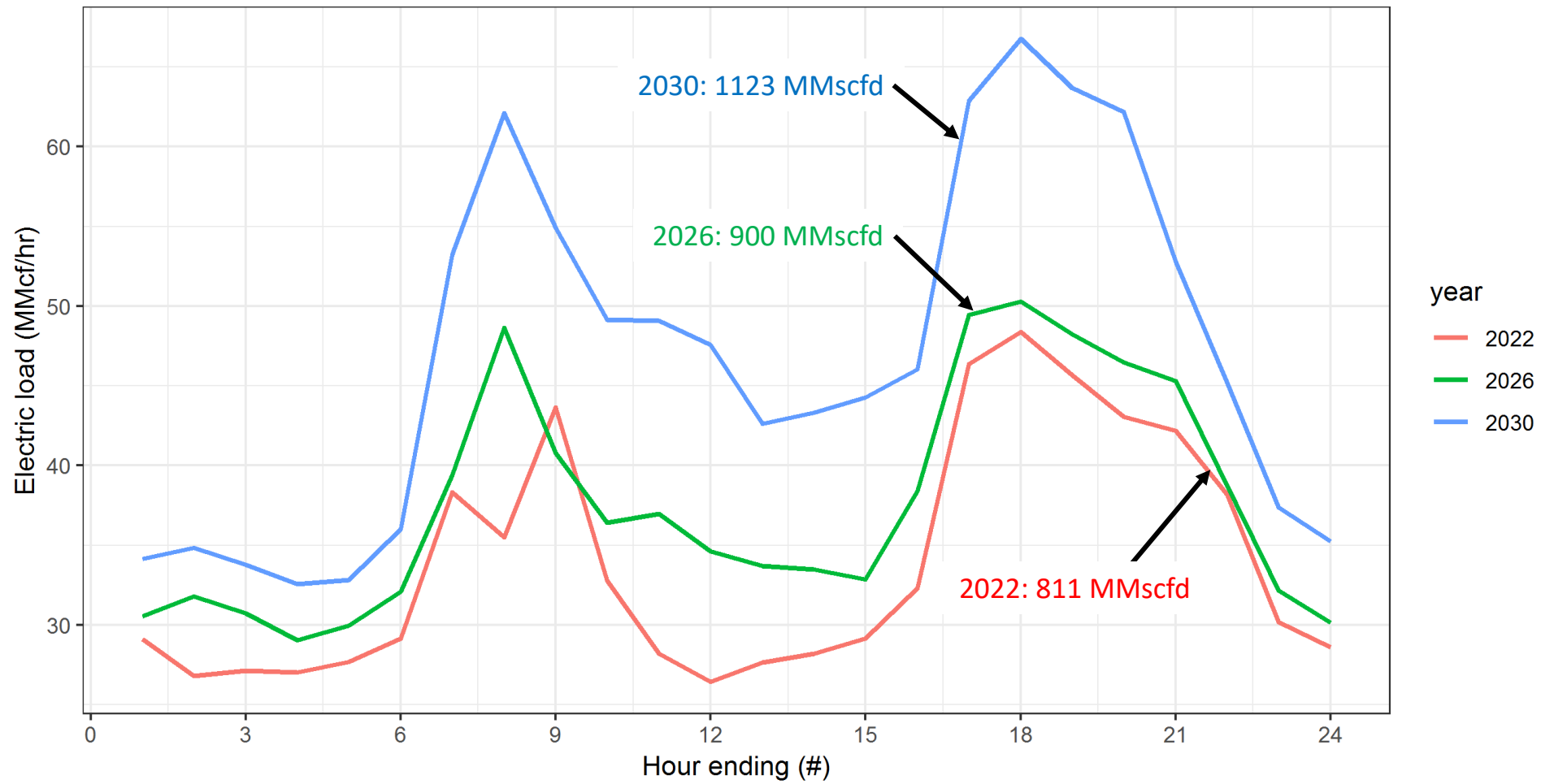

Source: Production Cost Modeling, Energy Division

Part I: Hourly Profiles of Natural Gas Use

SoCalGas Wholesale, Refinery, and Enhanced Oil Recovery Customers





Wholesale, Refinery, and Enhanced Oil Recovery Customers

- Wholesale, Refineries, and Enhanced Oil Recovery are assumed to have a constant demand throughout the day.
- Therefore, the profiles are “flat”, i.e. the normalized value is 1 for all 24 hours.
- Staff is adopting these profiles because:
 - Flat profiles will not increase reliance on storage. They don't rely on linepack because they lack gradients.
 - 2018 AMI data doesn't show a distinct profile for these subclasses.
 - Only a few customers belong to these subclasses.



Total Load Profile (Simulation 01)

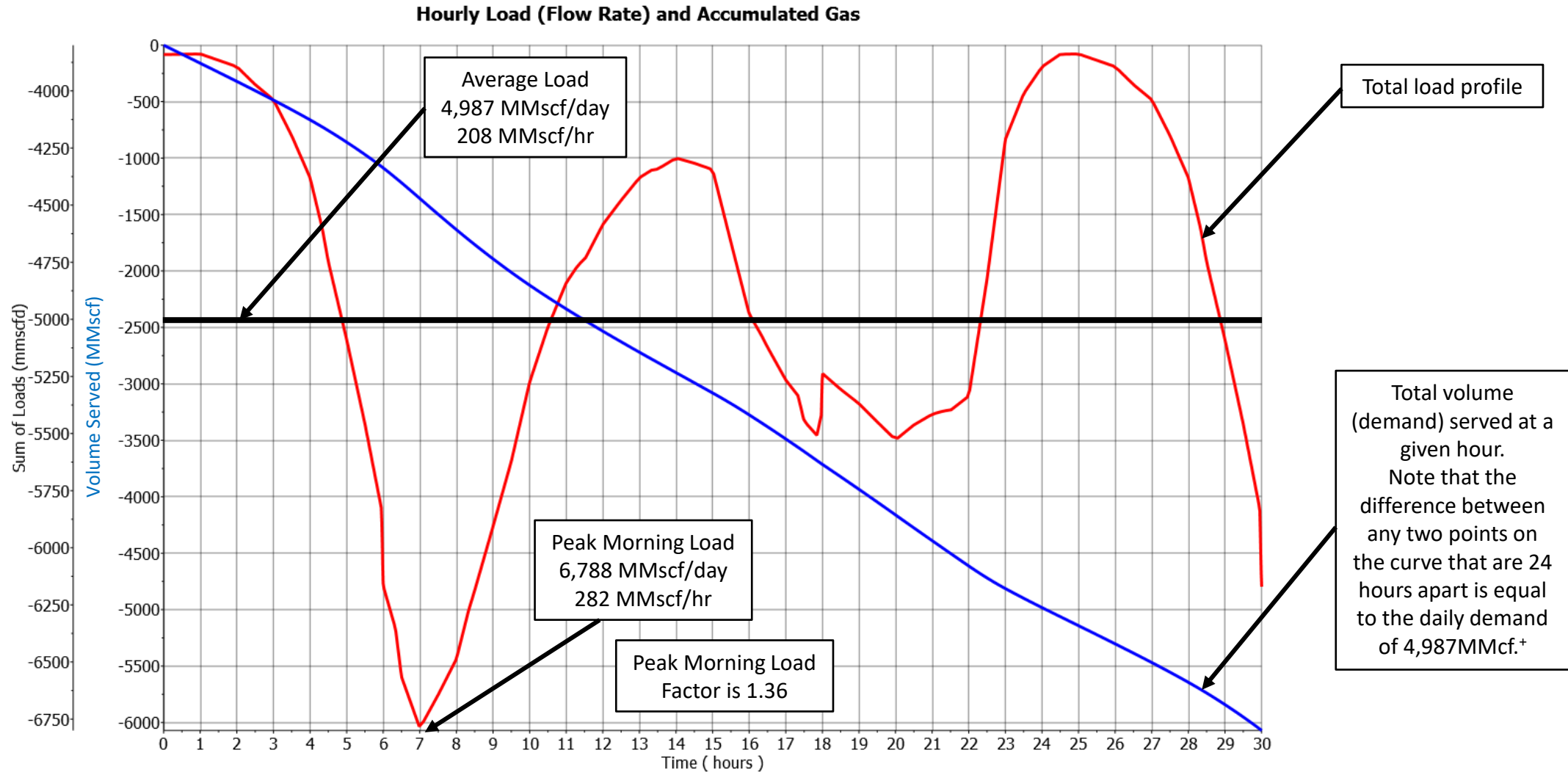

+ This curve is the integral of the demand profile over time.



Conclusions

- Hourly profiles of natural gas use of core customers shows variation across ZIP codes.
- Aggregation of the profiles validates SoCalGas core hourly profile that has been used in previous assessments and new simulations.
- Sensitivity on Simulation 01 (Winter 2020) showed negligible “integral” effects (e.g. system Linepack) from including 157 profiles for core customers rather one aggregate profile.
- However, the differences across the ZIP codes may become important for long-term planning and potential demand reduction or peak shaving.



Part I: Hourly Profiles of Natural Gas Use

Discussion



Part II: Capacity Studies Preliminary Results

Introduction





Introduction

- Why perform a capacity study?
 - Receipt Point Utilization was based on nominal capacities of the 3 different zones (Southern, Northern, and Wheeler Ridge); validate nominal capacities.
 - Understand the hydraulics of the network.
 - Reveal bottlenecks and competition if any.

Zone	Nominal Capacity (MMscfd)	Receipt Point Utilization(%)+	Supplies (MMscfd)
Southern	1,210	85%	1,028.5
Northern	1,590	85%	1,351.5
Wheeler Ridge	765	100%	765.0
Total without outages	3,565	88%	3,145

+ As introduced in workshop 1, Staff is using RPU to calculate supplies based on the nominal capacity of the zone, as opposed to SoCalGas approach, where RPU is based on the system capacity after a given set of outages has been introduced (and hence lowered the capacity).



Introduction



Illustration of SoCalGas Natural Gas Transmission Network



Introduction

- There are many variations of how to conduct a zonal capacity study. For example, using steady state analysis:
 - Variation I: specify MOP (Maximum Operating Pressure) at key nodes (receipt points, pressure regulators) and a small flow rate (i.e. demand or supply).
 - Solve for the unknown pressure at the demand nodes (primarily the LA basin).
 - As long as these pressures remain above MinOP (Minimum Operating Pressures), the zone under analysis is able to meet the specified demand at the specified demand distribution.
 - Increase the demand incrementally and re-establish the steady state (i.e. find a solution for the unknown pressures). The maximum demand that can be met without violating the MinOP or any other constraint is the zonal capacity.



Introduction

- Variation II: specify the MinOP at key nodes (e.g. in the LA basin) and specify a small flow rate (i.e. demand).
 - As long as the upstream pressures remain below MOP, the zone under analysis is able to meet the specified demand.
 - Increase the demand incrementally and re-establish the steady state. The maximum demand that can be met without violating the MOP or any other constraint is the zonal capacity.
- Variation III: specify both MOP and MinOP at key nodes and solve for the unknown flow rates at the receipt points, which would be the zonal capacity. It is difficult to find a solution using this approach in Synergi.



Introduction

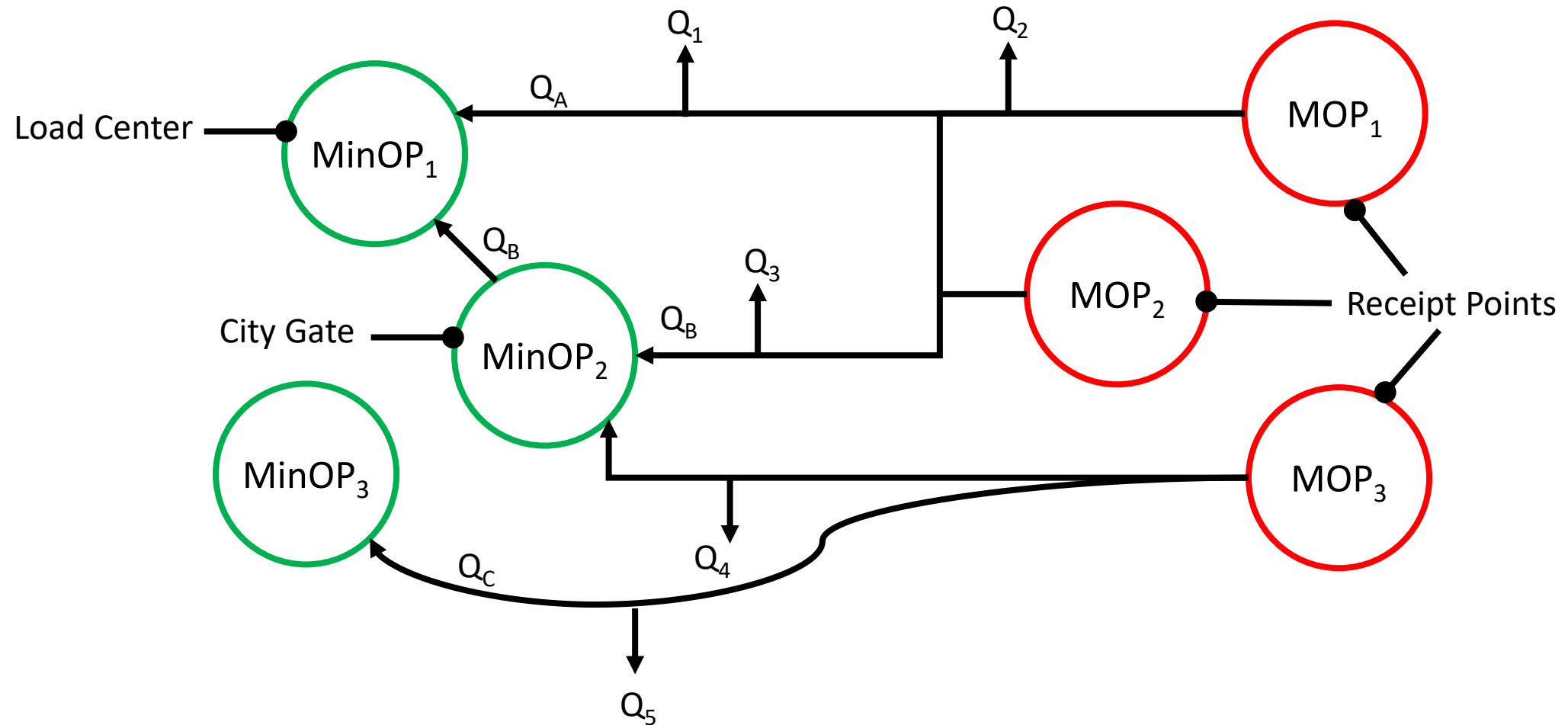



Introduction

- Variation I will be used, i.e. specify MOP and demand, then monitor other constraints and all pressures until they fall below MinOP.
- Assumptions must be made regarding the demand “configuration” or “distribution”. In other words, being able to serve 1 Bcfd of demand inside the LA basin is not equivalent to serving 1 Bcfd in SDG&E territory or the coastal area. A demand configuration equivalent to the 1-in-10 2020 winter demand will be used.
- It may be desired to perform the zonal capacities study using a transient analysis. However this would require making more assumptions regarding the hourly gas profiles of all customer classes, pressure regulators set points, and operational actions, including possibly storage withdrawals and injections.



Introduction

- Compared to the results of a transient analysis, a steady state analysis will yield an upper bound of the zonal capacity. Presence of transients (e.g. hourly demand variation) will likely decrease this daily capacity.
- Each zone will be studied independently thereby eliminating any possible competition from the other zones, which may point towards “bottlenecks”.
- A system capacity study will be necessary to complete the analysis.

Part II: Capacity Studies Preliminary Results

The Southern Zone





Southern Zone Capacity Study

- 3 Transmission lines
- 3 Receipt points
- 2 Compressors
- Multiple regulators
- 2 Regulators into the LA basin

- Total loads along the transmission lines, SDG&E and the LA basin are 3,855 MMscfd for the 2020 1-in-10 winter peak.

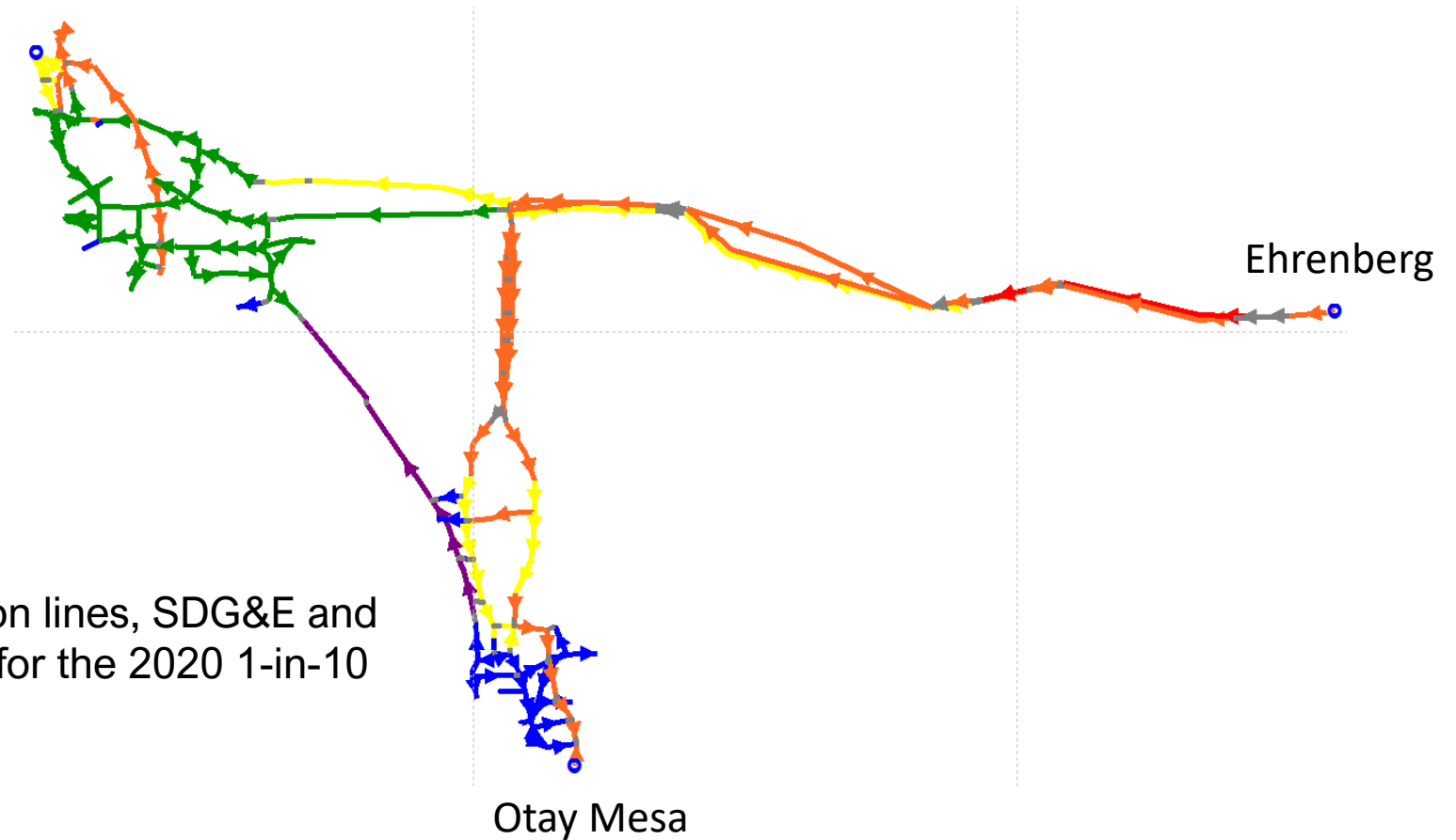



Southern Zone Capacity Study

- Major parameters set on the Southern Zone:
 - Receipt pressure at Ehrenberg set to MOP.
 - All set pressures of regulators on L2000, L2001, and L5000 set to pipeline MOP⁺.
 - Discharge pressure of compressors is set to pipeline MOP^{*+}.
 - Otay Mesa receipts are set to zero.
- Constraints monitored:
 - Compressors' utilization factor.
 - Pipeline pressure everywhere.

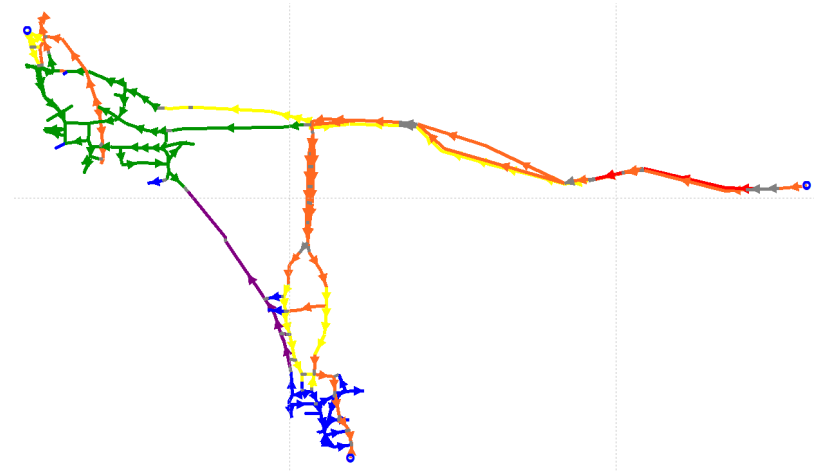

⁺ Set pressure may be decreased slightly in order to avoid MOP violations on downward sloping pipes

^{*} Provided that it does not exceed the compressor station limitations



Southern Zone Capacity Study

Incremental Load Increase on the Southern Zone by 2.5% (96.35MMscfd)

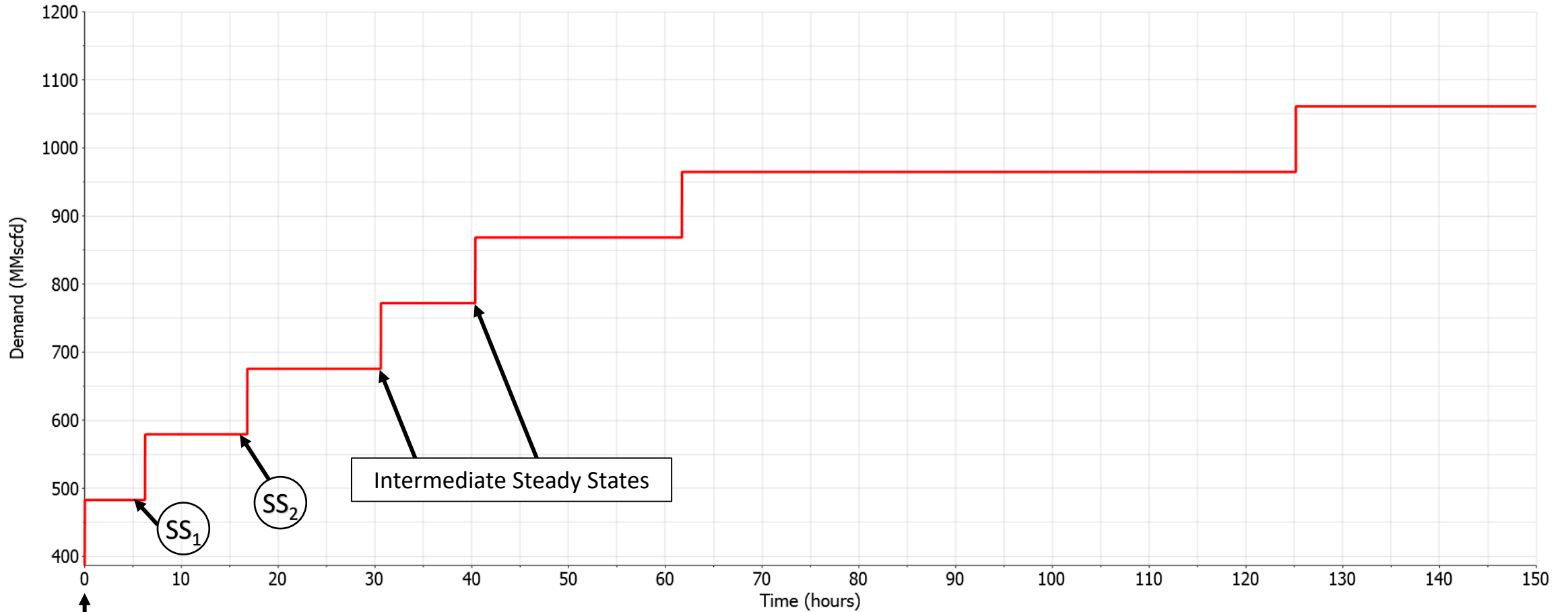

Initial Steady State (SS₀): 10% of 3,855 MMscfd = 387MMscfd



Southern Zone Capacity Study

Incremental Load Increase on the Southern Zone by 2.5% (96.35MMscfd)

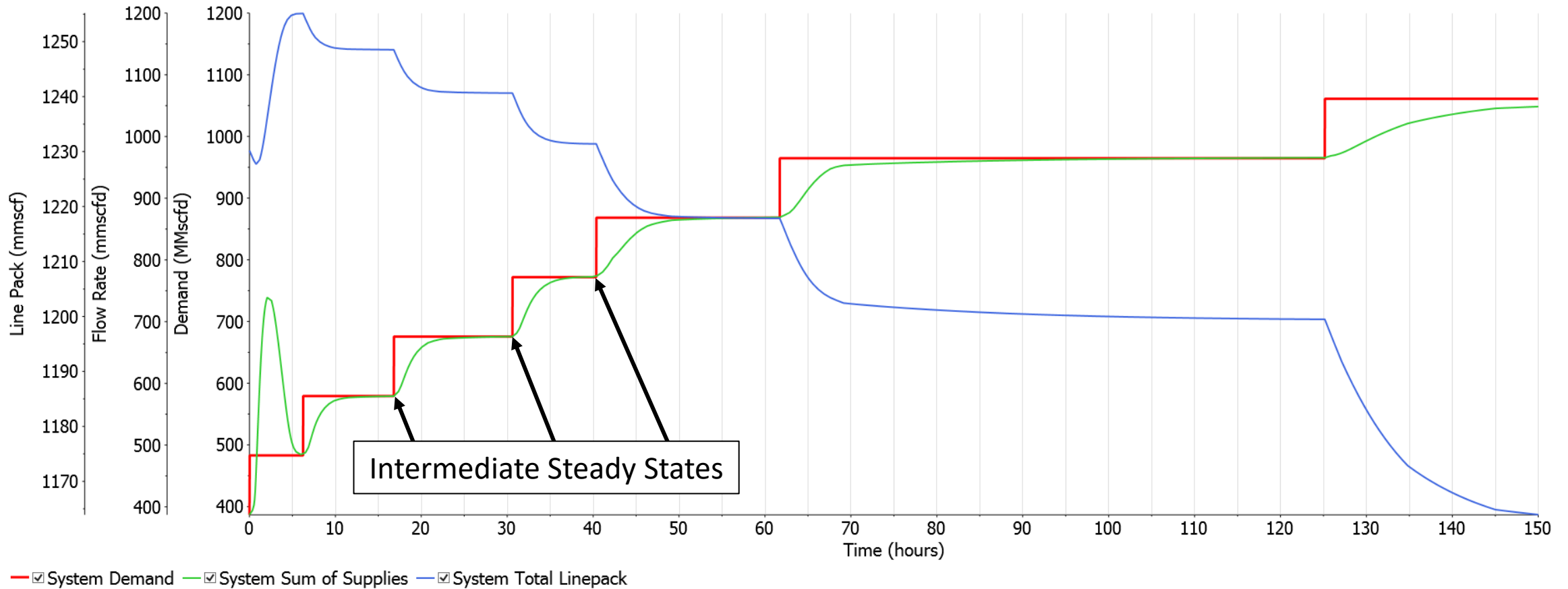



Southern Zone Capacity Study

Pressure Plots of Multiple Nodes Across the Los Angeles Basin

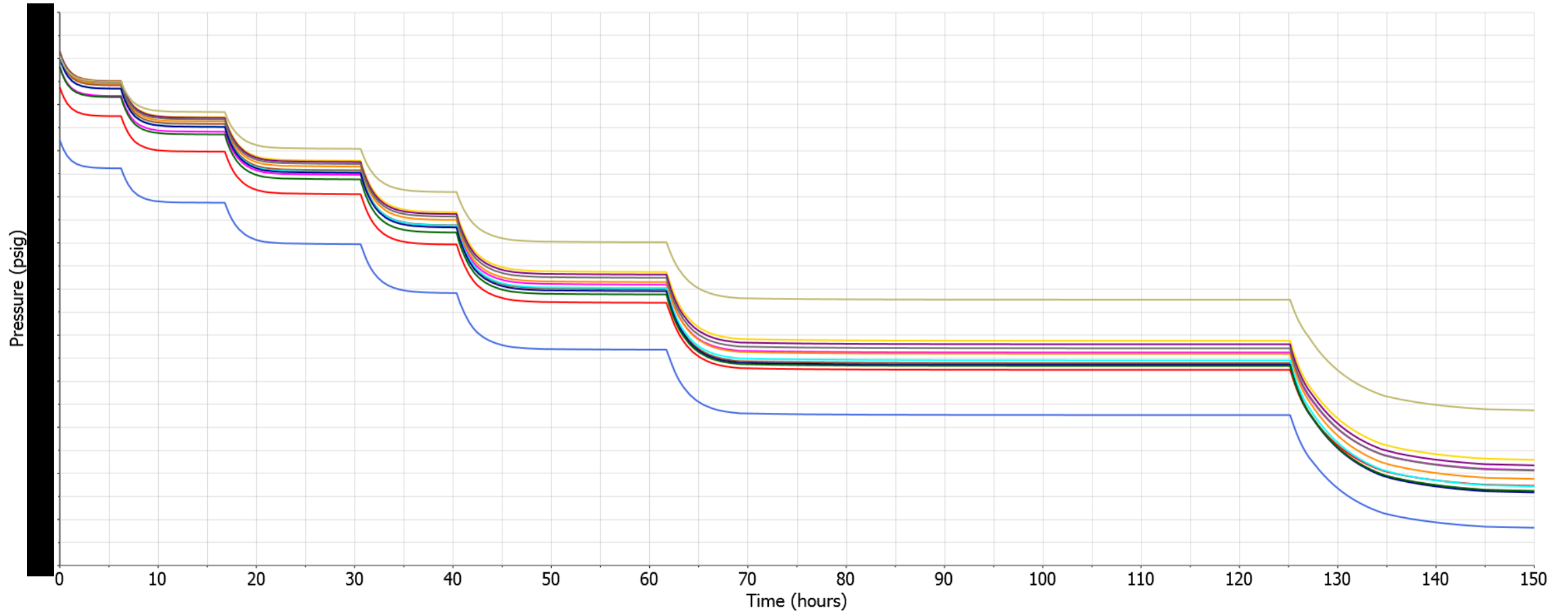



Southern Zone Capacity Study

Incremental Load Increase on the Southern System (+2.5% or 96.35MMcfd)

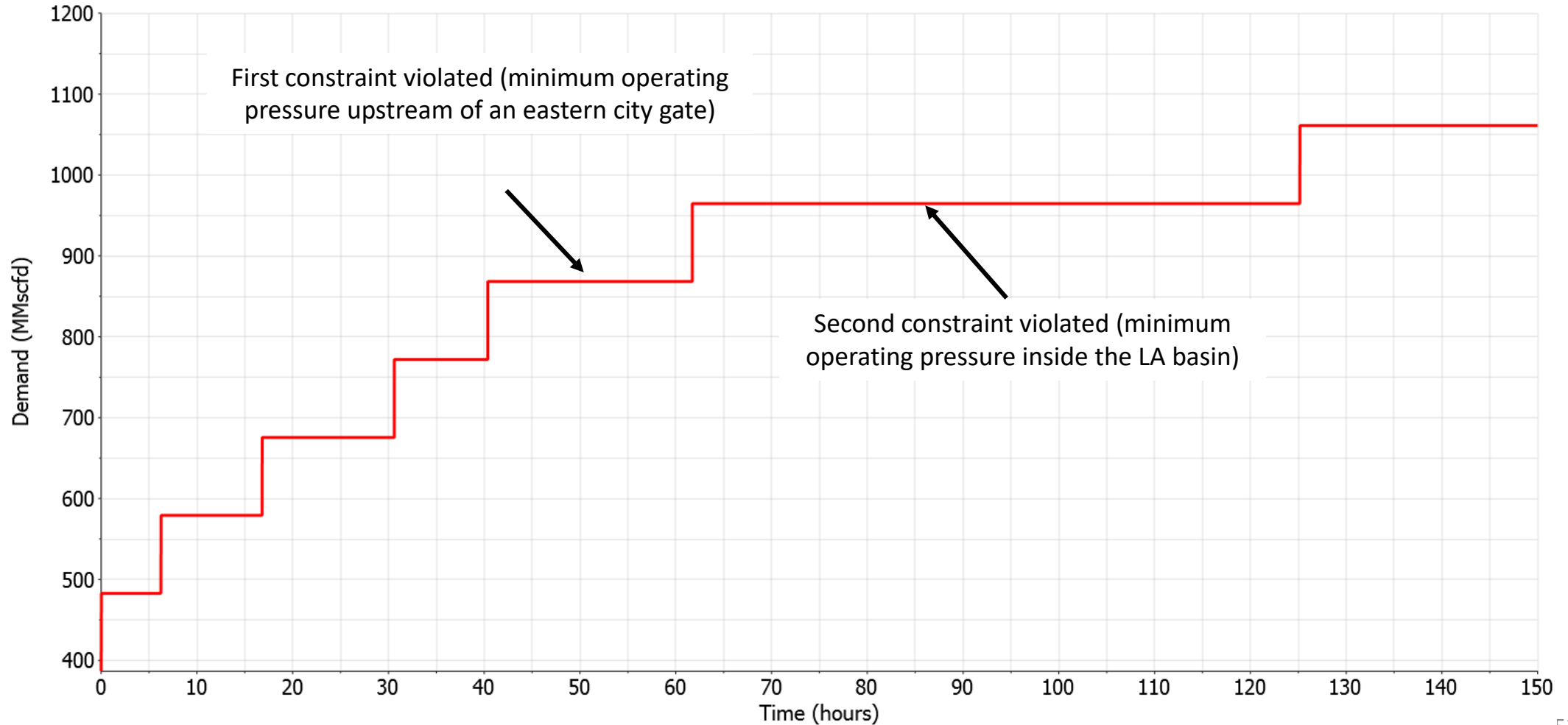



Southern Zone Capacity Study

Study	Regulator East L2000	Regulator East L2001	Supplies at 1 st constraint violation	Supplies at 2 nd constraint violation	SoCalGas Stated Nominal Capacity
	Set pressure		MMscfd	MMscfd	MMscfd
S1	MinOP	MinOP	868	1061	1,210
S2	MOP	MOP	1061	1157	

- Serving all loads along the transmission lines will likely increase the zonal capacity to 1,210 MMscfd.
- Is it favorable to operate a pipeline with all pressure regulators, set to MOP (Study S2)?+

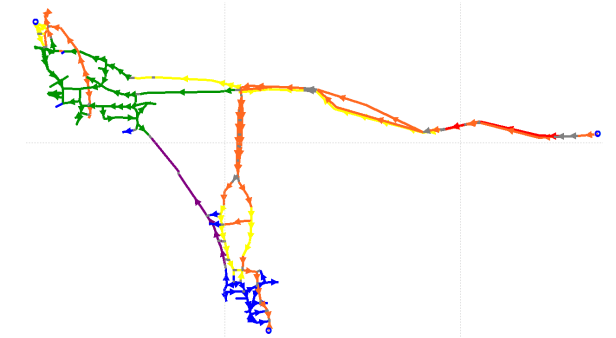

+ Answer is no. Operator is said to “lose control over the network” once pressure regulators are fully open and not regulating



Southern Zone Capacity Study

- Instead of showing the results of in “time” plots format, a table may be constructed for study S2:

Demand Percentage ⁺	Demand MMscfd	MOP Violated	MinOP violated outside LA basin	MinOP violated in LA basin
10.0%	387	No	No	No
12.5%	483	No	No	No
15.0%	576	No	No	No
17.5%	676	No	No	No
20.0%	772	No	No	No
22.5%	868	No	No	No
25.0%	965	No	No	No
27.5%	1061	No	Yes	No
30.0%	1157	No	Yes	Yes

+ Percentage of demand served along major transmission lines, SDG&E, and, the LA basin only (3,855 MMscfd)



Southern Zone Capacity Study

- Observations from the Southern Zone capacity study:
 - A higher demand results in a lower linepack.
 - The higher the demand, the longer it will take to recover or draft the linepack.*
- While this simulation needed not to be “accurate-in-time”, it is noteworthy how the pipeline network responds to increasing load:
 - Pressure regulators keep switching from the “regulating” state to “opened” state one after the other.
 - Following that, the pressure downstream of the pressure regulators starts to drop below the “desired” set pressure until it drops below MinOP.
 - If allowed to continue, the simulation might keep running until some pressure reaches the zero absolute or some other unphysical condition develops.

* This is evident from the “slow transient” or momentum-less results. Higher order models may yield different results.

Part II: Capacity Studies Preliminary Results

The Northern Zone





Northern Zone Capacity Study

- 3 receipt points
- 5 compressors
- 3-4 city gates
- Multiple regulators and crossover valves
- Study N1:
 - Using 4/5 city gates, i.e. all Eastern and Northern city gates
 - Total Load 3,195MMscfd

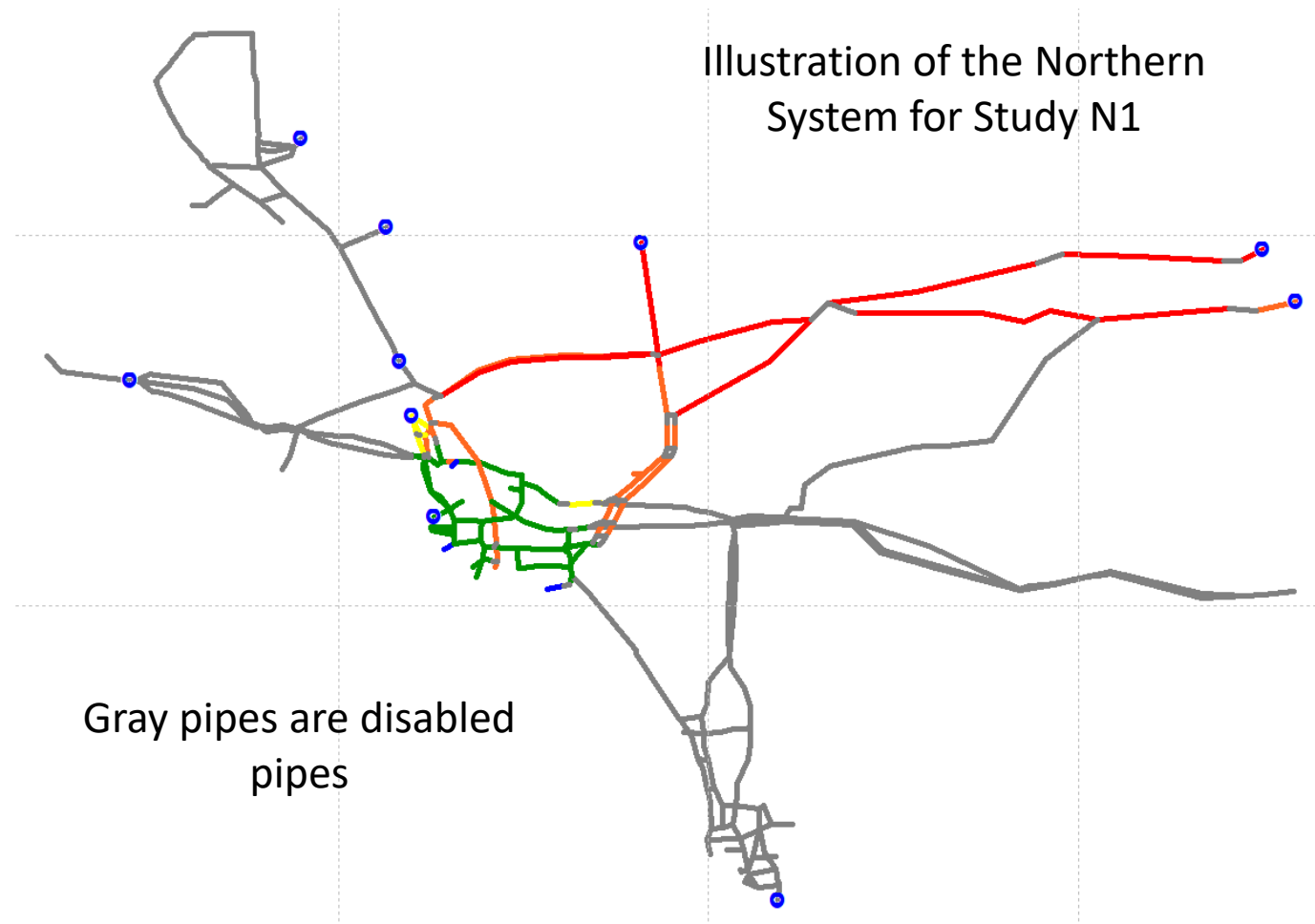



Northern Zone Capacity Study

- Major parameters set on the Northern zone:
 - Receipt pressure at Needles, Topock, and Kramer are set to MOP.
 - All set pressures of regulators on L3000, L235, L4000, and L4002 are set to pipeline MOP⁺ (i.e. without the reductions imposed in Simulations S01-S06).
 - Discharge pressure of compressors is set to pipeline MOP.*⁺
- Constraints monitored:
 - Compressors' utilization factor.
 - Pipeline pressure everywhere.

⁺ Set pressure may be decreased slightly in order to avoid MOP violations on downward sloping pipes

* Provided that it does not exceed the compressor station limitations

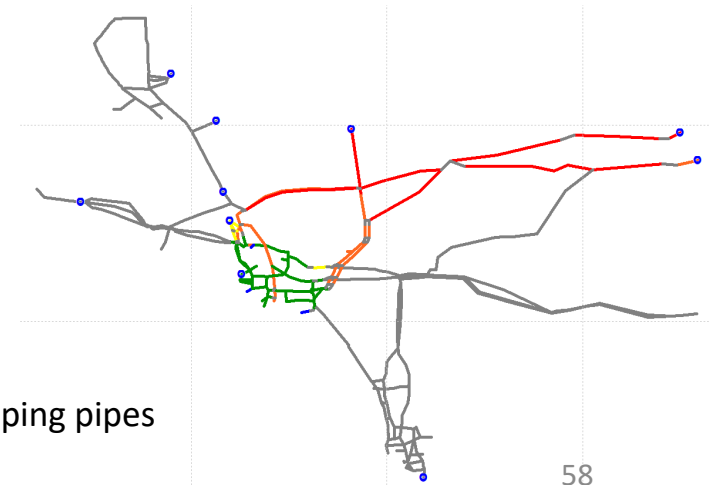



Northern Zone Capacity Study (N1)

Incremental Load Increase on the Northern Zone by 2.5% (79.87MMscfd)

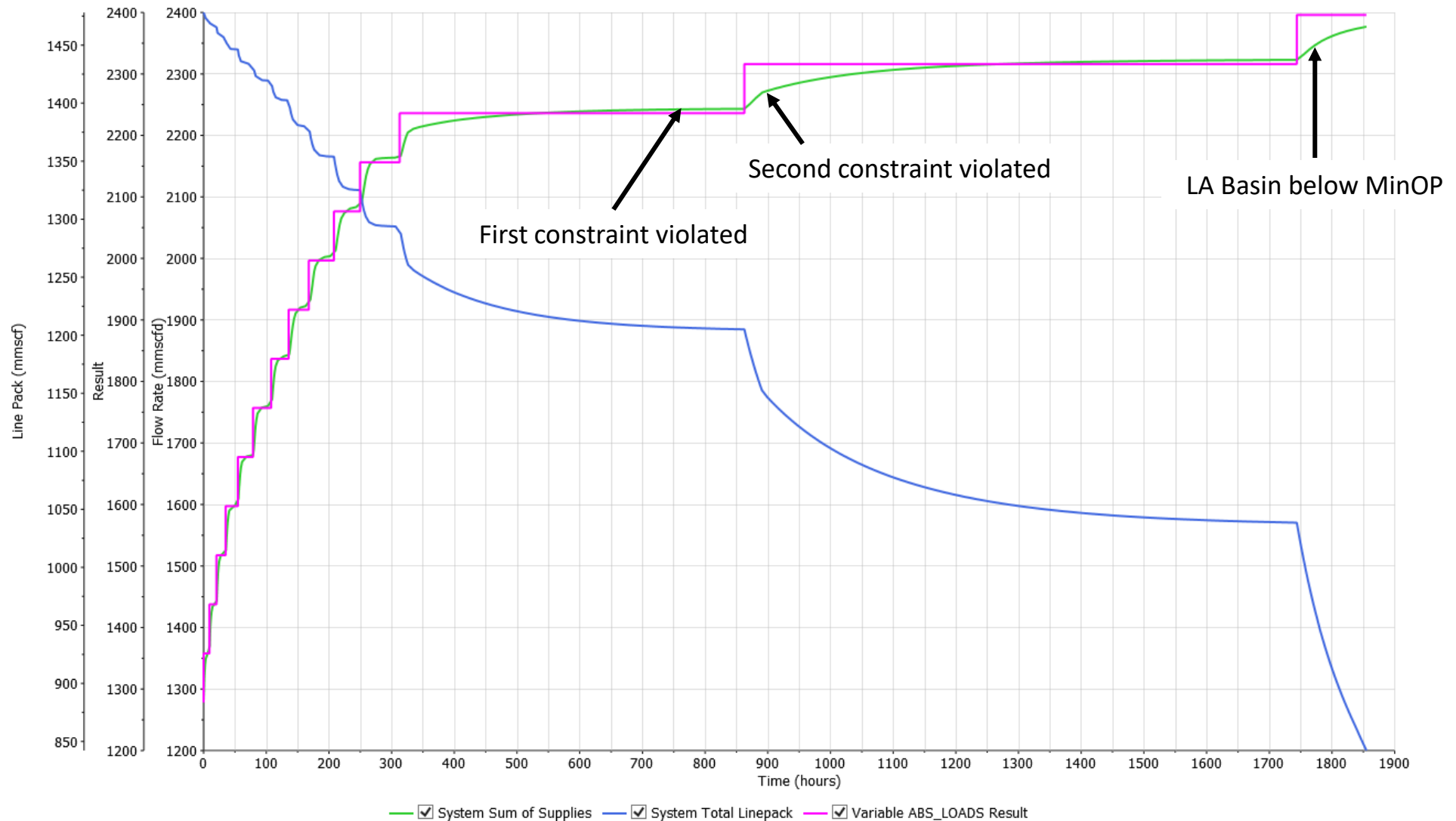



Northern Zone Capacity Study

- 3 receipt points
- 5 compressors
- 3-4 city gates
- Multiple regulators and crossover valves
- Study N2:
 - Using 3/5 city gates, i.e. only the Eastern city gates.
 - Total Load is 3,098MMscfd

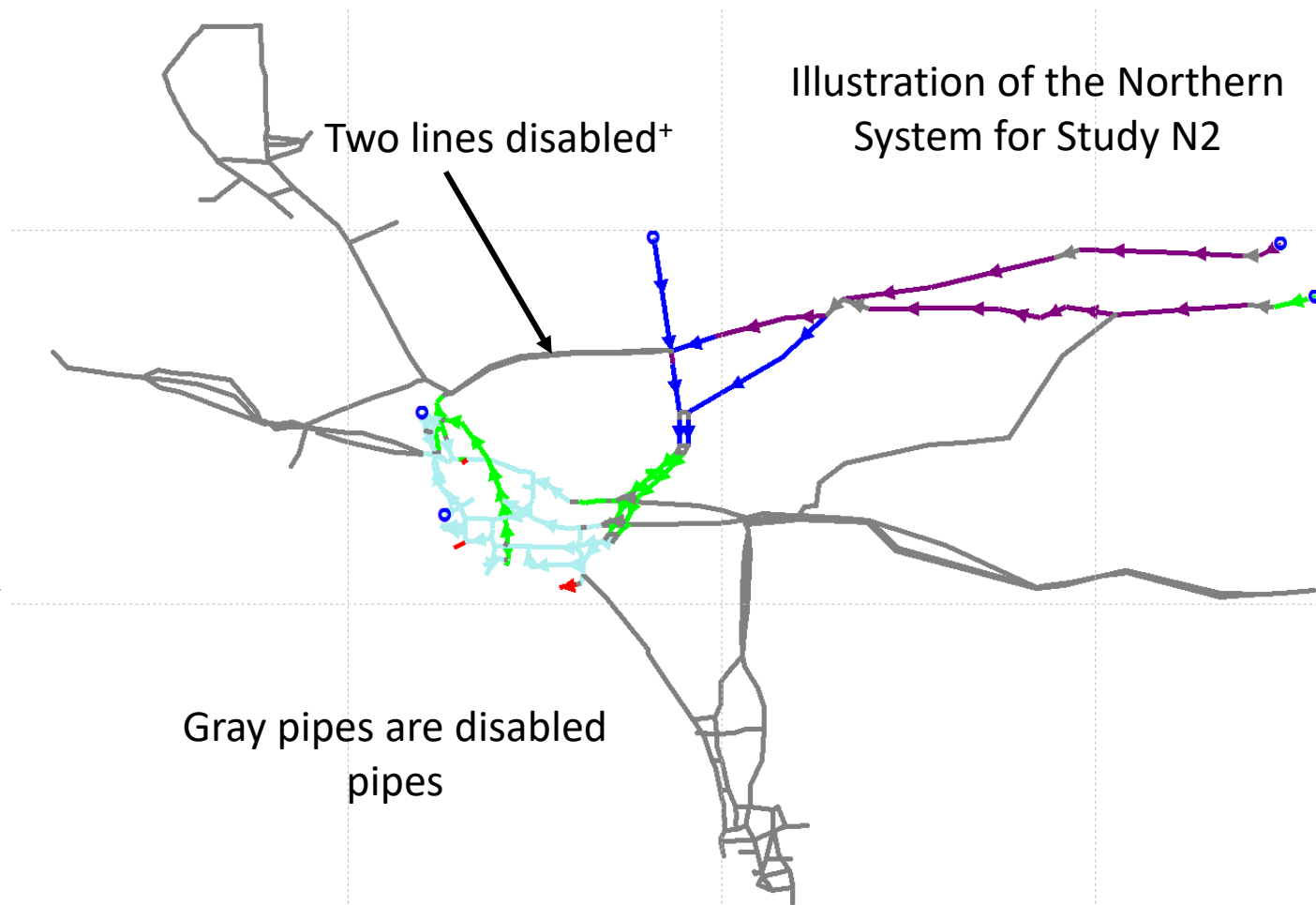

+ The load connected along these two lines is ~97 MMscfd



Northern Zone Capacity Study

Study	City Gates Configuration	Supplies at 1 st constraint violation	Supplies at 2 nd constraint violation	Supplies when LA basin failed
		MMscfd	MMscfd	MMscfd
N1 ⁺	4 City Gates	2,243 ⁺	2,255 ⁺	2,340 ⁺
N2 ⁺	3 City Gates	2,013 ⁺	2,013 ⁺	2,091 ⁺

+ The capacities shown for studies N1 and N2 assume no competition from the other zones.

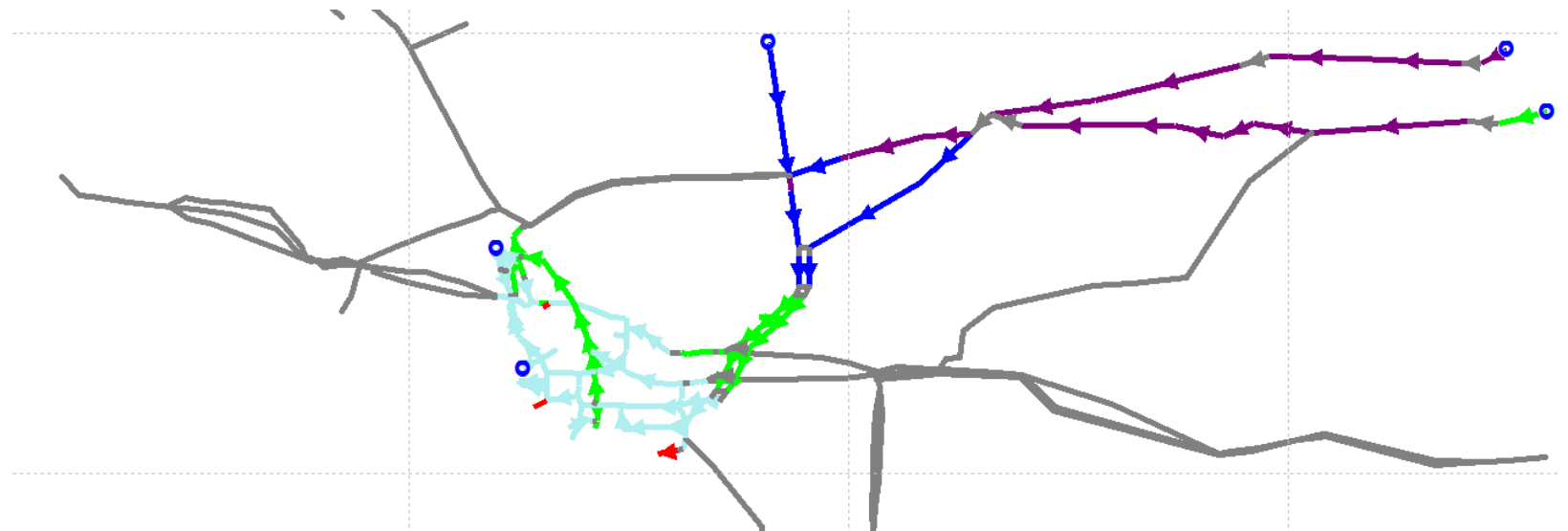



Conclusions

- The Southern Zone nominal capacity of 1,210 MMscfd has been validated. Using 85% receipt point utilization of the nominal capacity in simulations 01-06, which yields 1028.5 MMscfd has been validated.
- The Northern Zone capacity may be as high as 2,243 MMscfd, which is much higher than the stated nominal capacity of 1,590 MMscfd.
- However this is due to the removal of the competition from the Wheeler Ridge Zone, which competes at least on L235, L335, L1185, L4002, and the Northern city gate.



Conclusions

- The competition with the Wheeler Ridge Zone will reduce the Northern Zone Capacity by 230-700 MMscfd due to flow reversal on L235 and L335. This would bring the nominal capacity of the Northern Zone closer to the stated nominal of 1,590MMscfd.
- Possible bottleneck identified; the Northern city gate.

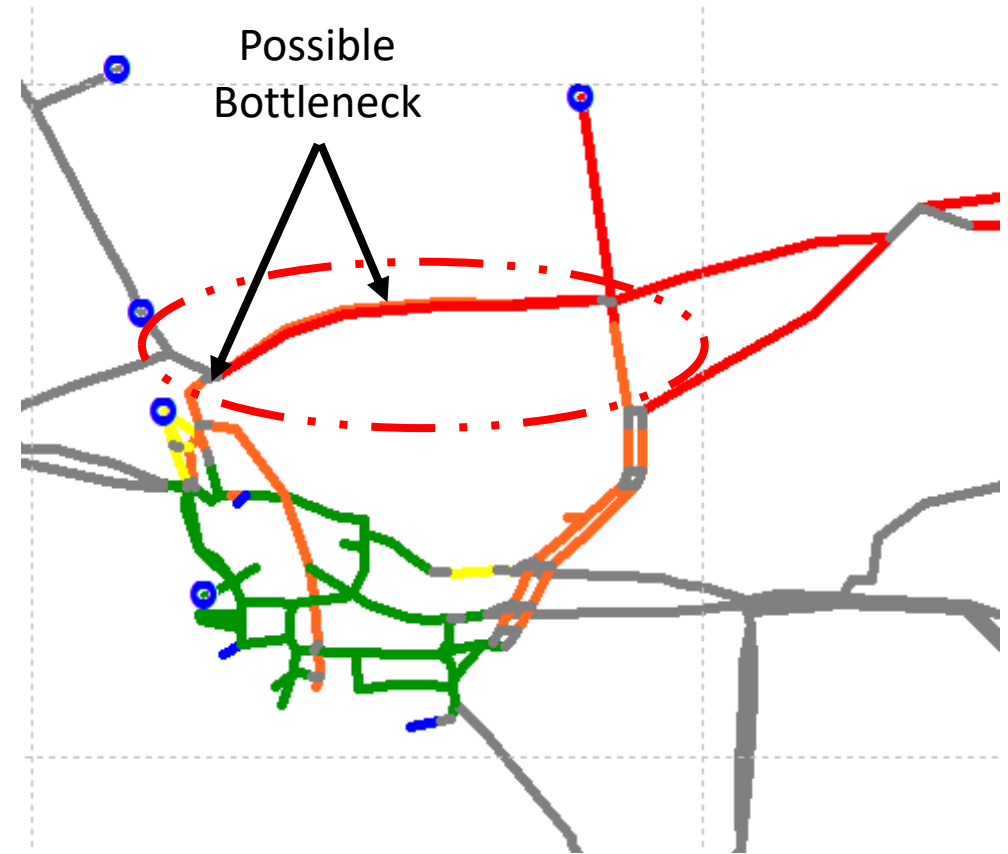



Conclusions

- Mitigation of this bottleneck by, for example, increasing the capacity of the Northern city gate should be investigated in Phase III of this OII.
- This is because the pipelines downstream of the city gate may not support a higher flow rate due to MOP constraints.
- The analysis of the Northern Zone will have to be coupled with the analysis of the Wheeler Ridge Zone in order to compute the maximum system capacity.



Future Work Leading to Phase III

- Future work must include:
 - Wheeler zone capacity study
 - System capacity study
 - Sensitivity when introducing one or more outages
- Future work may also include:
 - Sensitivity on set pressures (receipt points, regulators, and compressors)
 - Transient analysis of zonal capacities
 - Optimization module in Synergi



Thank you

Discussion

